

www.luxform.com/files/Solar_Intelligent_Hybrid.pdf



NL
GB
D
F
E
P
I
S
FIN
N
DK
GR
CZ
PL
SL
RO
LT
EST
LV
H
RUS

Scan mij voor meer informatie
Scan me for more information
Scannen Sie mich für weitere Informationen
Flashez moi pour plus d'informations
Escanear me para más información
Digitalizar me para mais informações
Scansione me per ulteriori informazioni
Skanna mig för mer information
Skannata kerron lisää
Skanne meg for mer informasjon
Scanne mig for mere information
σάρωση μου για περισσότερες πληροφορίες
Skenovani me pro více informací
Skanować mi więcej informacji
Skeniranje me za več informacij
Scanare mă pentru mai multe informații
Nuskaityti manęs daugiau informacijos
Skaneerida minuga rohkem teavet
Skenēt ar mani vairāk informācijas
Atkutat en további informáciokat
сканировать мной для получения
дополнительной информации



SOLAR INTELLIGENT HYBRID MINNESOTA WALL LIGHT

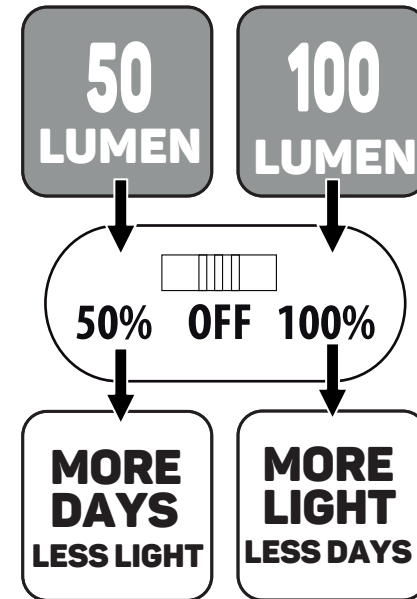

Luxform Global BV Transportstraat 1 8263 BW Kampen The Netherlands

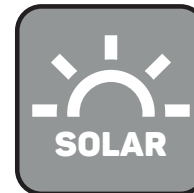

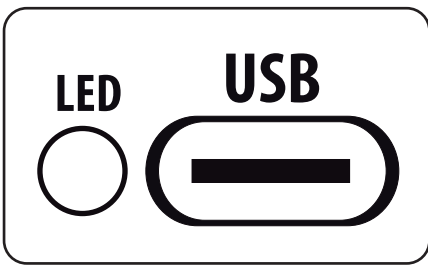
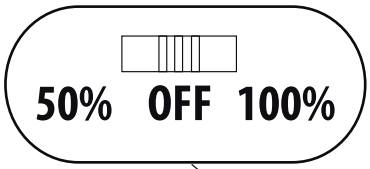
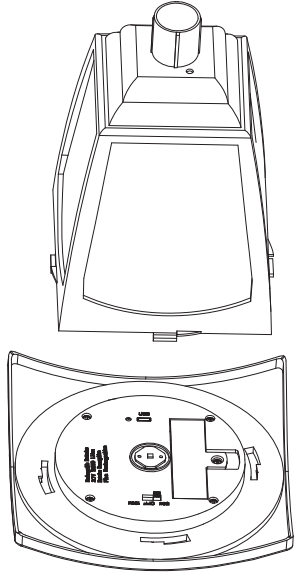
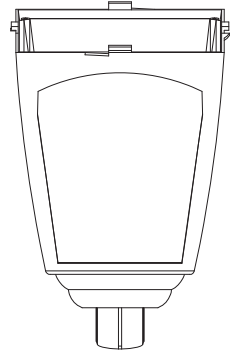
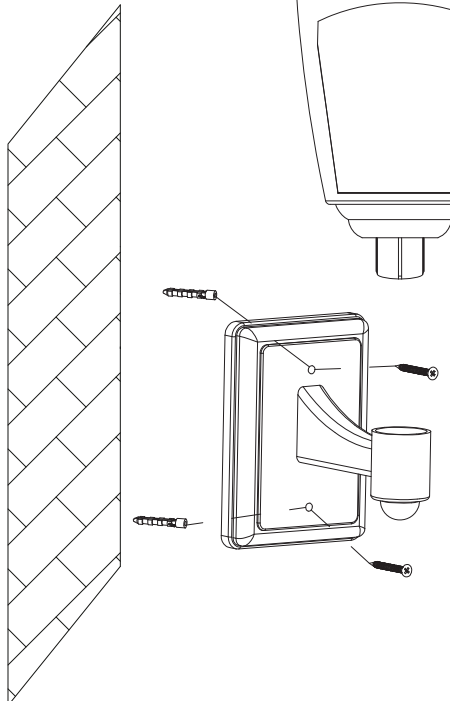

Lights up RED when loading
 Lights up GREEN when fully loaded



1,5MTR included

Loading needs to be done indoors
 120 min. charge for full battery

